



Pluriservicios Biomédicos S.A. de C.V.

EQUIPO MEDICO Y SOPORTE TECNICO
R.F.C. PBI0312022S1



Mínimo \$ 47,413.79

Máximo 474,137.93 //

Ciudad de México, a 19 Enero del 2020.

INSTITUTO NACIONAL DE CIENCIAS MÉDICAS Y NUTRICION "SALVADOR ZUBIRÁN"
C.P. AURELIO JAIME LOZANO GÓMEZ
JEFE DE MANTENIMIENTO
PRESENTE
ATENCION ING. EMILY MORALES ARCOS
COORDINADORA DEL DEPARTAMENTO DE MANTENIMIENTO

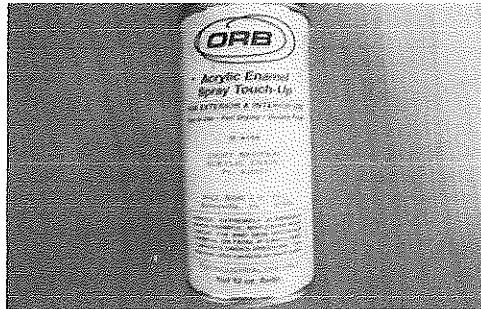
A continuación ponemos a su amable consideración la siguiente cotización de Refacciones para las Camas Eléctricas y Camas Manuales Marca HILL ROM
Vigencia 01 de Marzo del 2021 al 31 de Diciembre del 2021

No. partida	No. de clave almacen INCMNSZ	No. de parte	Descripción el producto	Imagen del producto	Precio unitario	Precio total
1	27017660	18942	Pintura epoxica grado medico (epoxy fine poder tch -up-taupe)		\$ 1,022.00	\$ 1,022.00
2	2701679	38827	Pintura color light neutral en spray para retoque grado medico		\$ 570.00	\$ 570.00

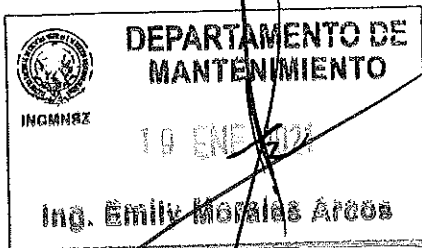

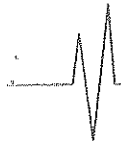

Pluriservicios Biomédicos S.A. de C.V.

EQUIPO MEDICO Y SOPORTE TECNICO
R.F.C. PBI0312022S1

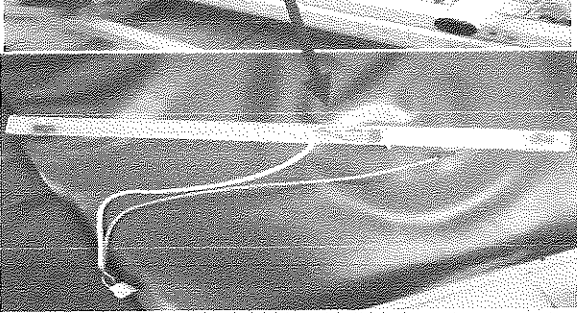
3	27017630	Regleta completa con micros y tarjeta de control, cables	Regleta completa con circuitos electrónicos para cama HILL- ROM CENTRA (head switch housing)		\$ 2,173.00	\$ 2,173.00
---	----------	--	--	--	-------------	-------------

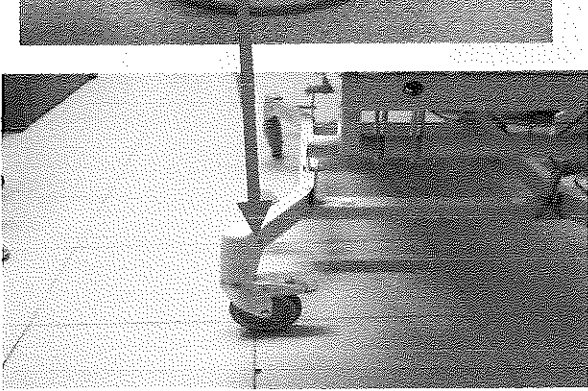
4	27017663	126325	Rueda de 5" para freno para camas MARCA HILL ROM MODELO CENTRA Y ADVANCED		\$ 3,500.00	\$ 3,500.00
---	----------	--------	---	---	-------------	-------------

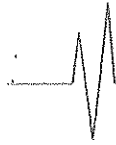

Pluriservicios Biomédicos S.A. de C.V.

EQUIPO MEDICO Y SOPORTE TECNICO
R.F.C. PBI0312022S1

5 27017665 126326

Rodaja completa
(goma de 5"
para freno)
para camas
MARCA HILL
ROM
MODELOS
CENTRA Y
ADVANCED

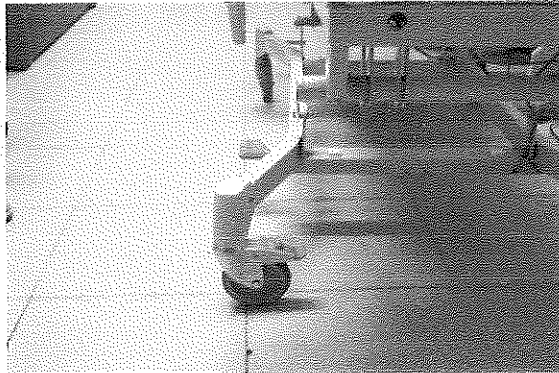
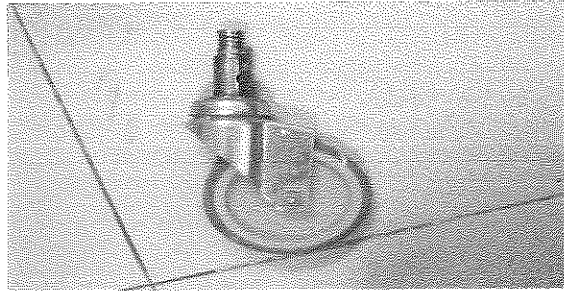

\$ 3,500.00 \$ 3,500.00

6 27017634 19833

Cubierta de
cable (wire
cover) para
camas MARCA
HILL ROM
MODELOS
CENTRA Y
ADVANCED

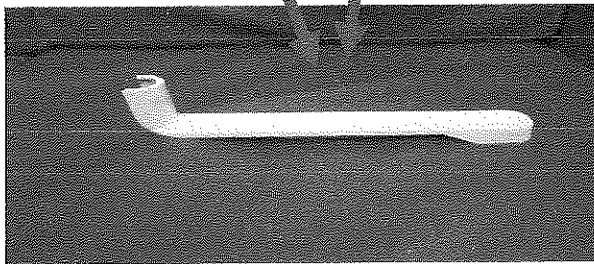
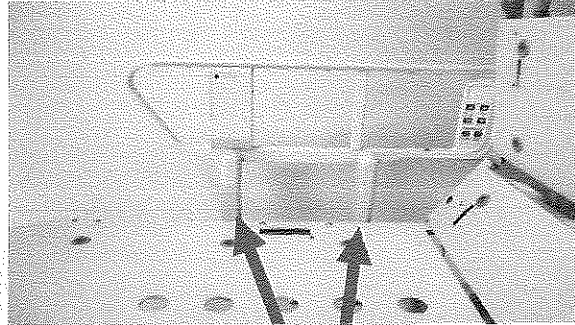

\$ 342.00 \$ 342.00

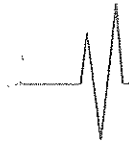

Pluriservicios Biomédicos S.A. de C.V.

EQUIPO MEDICO Y SOPORTE TECNICO
R.F.C. PBI031202281

7 27017662 31659

Porta
membrana
barandal
derecho
(control
housing Rh)
para camas
MARCA HILL
ROM
MODELOS
CENTRA.

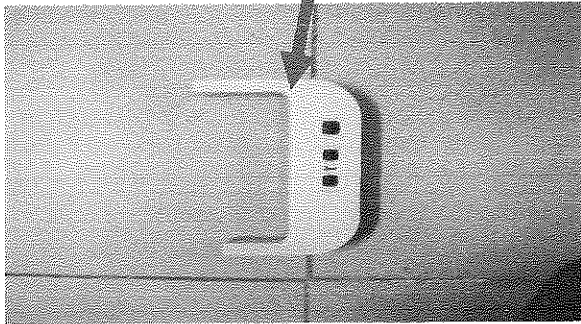

\$ 1,591.00 \$ 1,591.00 ✓

8 27017637

Cubierta
derecha
e
izquierd
a:
32612

Barandal
izquierdo
cubierta
superior para
camas MARCA
HILL ROM
MODELOS
CENTRA.

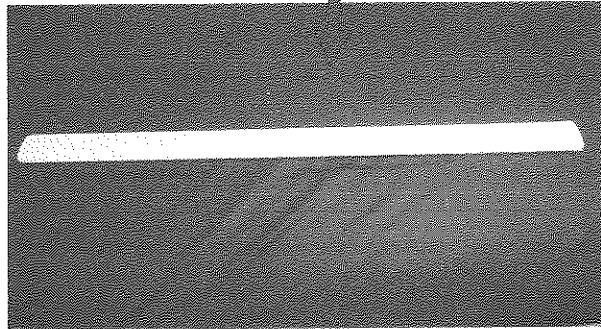
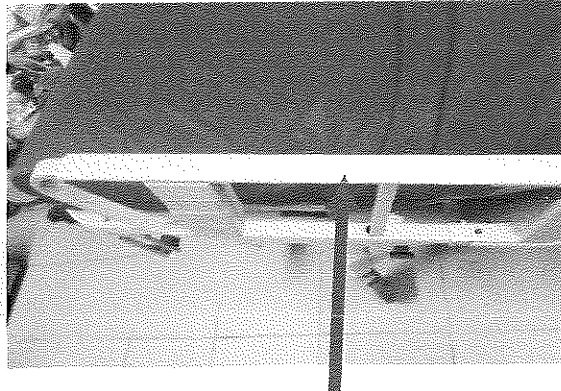

\$ 1,591.00 \$ 1,591.00 ✓

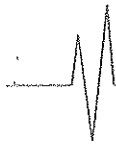

Pluriservicios Biomédicos S.A. de C.V.

EQUIPO MEDICO Y SOPORTE TECNICO
R.F.C. PBI0312022S1

9 27017666 3455733

Roller bumpers,
completos con
base y seguros
de fijación para
camas marca
Hill Rom
modelos
Centra,
Advanced y
Century CC

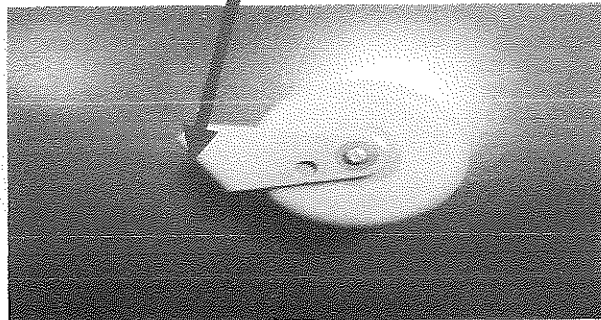

\$ 2,184.00 \$ 2,184.00

10 27017657 43370

Motor de
función de
respaldo
(sección
cabeza) para
camas marca
Hill Rom
modelo Centra
y Advanced

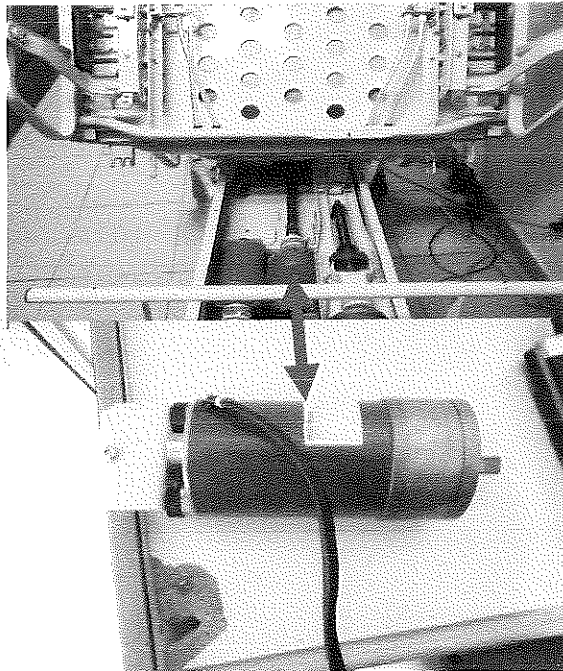

\$ 8,265.00 \$ 8,265.00



Pluriservicios Biomédicos S.A. de C.V.

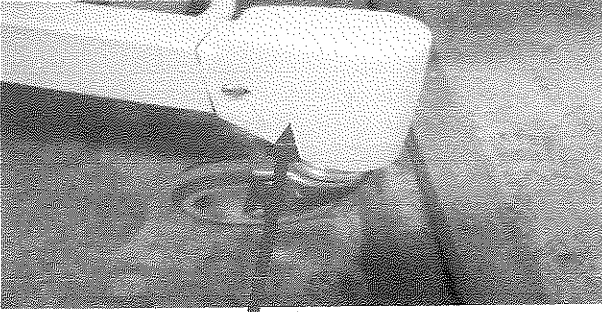
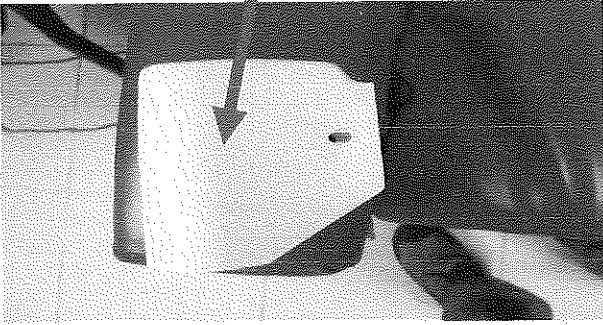

EQUIPO MEDICO Y SOPORTE TECNICO
R.F.C. PBI0312022S1

11	27017632	441003 3	Cubierta de llanta lado DERECHO (RIGHT SIDE TIRE COVER) para CAMAS MARCA HILL ROM, MODELO CENTRA Y ADVANCED		\$ 639.00	\$ 639.00	✓
12	27017618	491684 8	Cubierta de base central para cama marca Hill Rom modelo P1900		\$ 7,100.00	\$ 7,100.00	✓

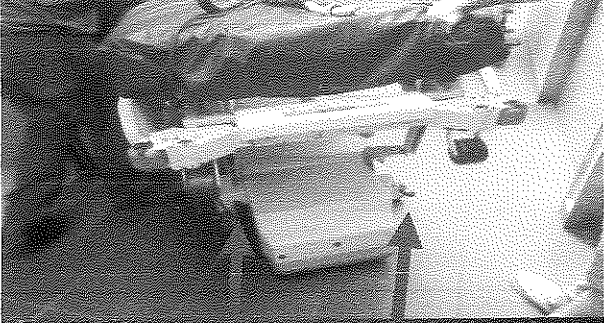
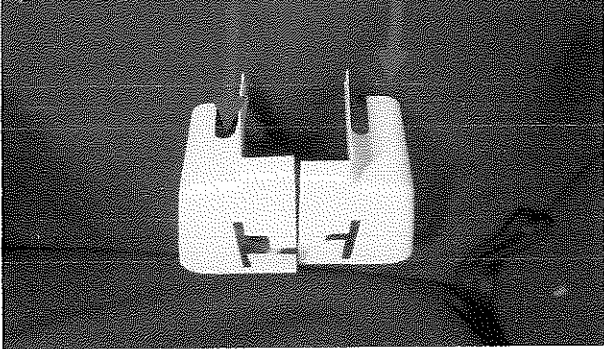

Pluriservicios Biomédicos S.A. de C.V.

EQUIPO MEDICO Y SOPORTE TECNICO
R.F.C. PBI0312022S1

13	Derecho	27017616	Izquierdo o No. de parte 491690 1	Cubierta de llanta (cabecera) lado izquierdo para cama marca Hill Rom modelo P1900		\$ 1,654.00	\$ 1,654.00
	Izquierdo	27017615	Derecho No. de parte 491690 2	Cubierta de llanta (cabecera) lado derecho para cama marca Hill Rom modelo P1900			
14	Derecho	27017611	Derecha No. de parte 491700 2	Cubierta base llanta de pies lado derecho para cama marca Hill Rom modelo P1900		\$ 1,850.00	\$ 1,850.00
	Izquierdo	27017610	Izquierda o No. de parte 491700 1	Cubierta base llanta de pies lado izquierdo para cama marca Hill Rom modelo P1900			

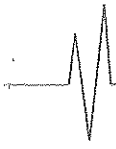

Pluriservicios Biomédicos S.A. de C.V.

EQUIPO MEDICO Y SOPORTE TECNICO
R.F.C. PBI0312022S1

15

491011
02

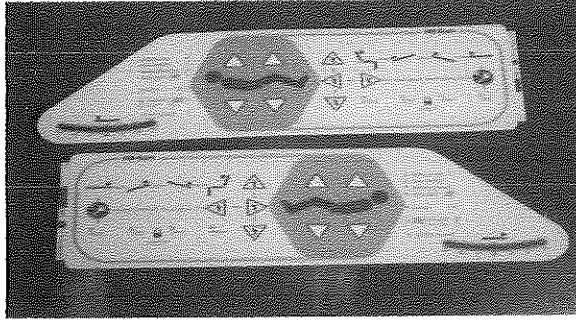

\$ 4,000.00 \$ 4,000.00 ✓

16

28009162

ASSY
428220
18

Tarjeta de
poder Assy y
42822, para
CAMA MARCA
HILL ROM
MODELO
CENTRA

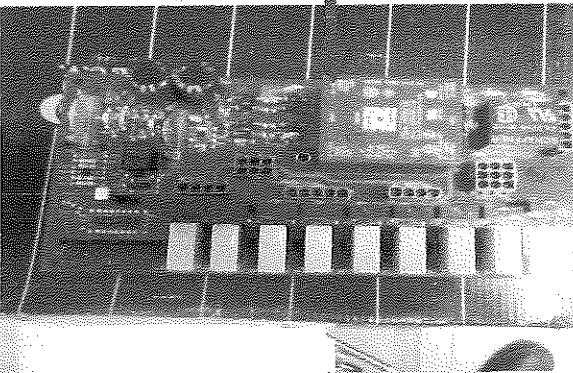

\$ 8,250.00 \$ 8,250.00 ✓

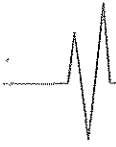

Pluriservicios Biomédicos S.A. de C.V.

EQUIPO MEDICO Y SOPORTE TECNICO
R.F.C. PBI0312022S1

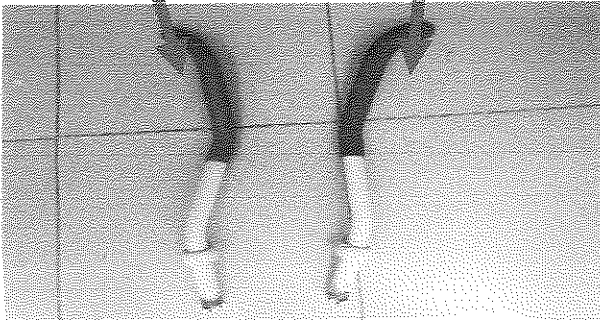
17	Derecho 27017628	Derecha No. de parte 495050 2	Asas de traslado izquierda y derecha para CAMA MARCA HILL ROM MODELO P1900		\$ 3,192.00	\$3,192.00
	Izquierdo 27018031	Izquierda No. de parte 495050 1				

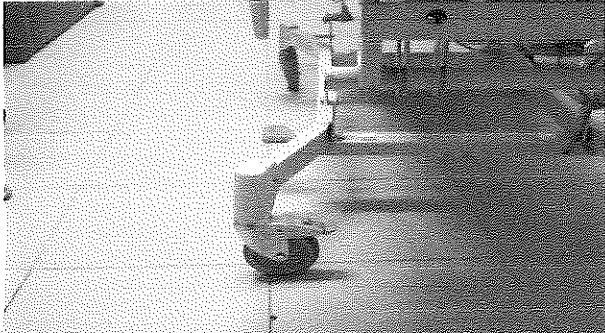
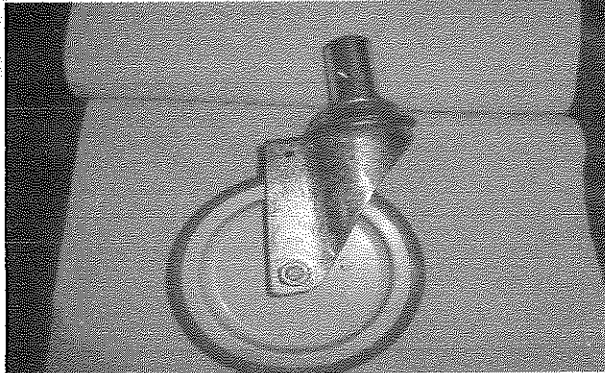
18	27017627	SA135 8	Rueda de 5" libre, para cama MARCA HILL ROM MODELO CENTRA Y ADVANCED		\$ 3,500.00	\$ 3,500.00
						

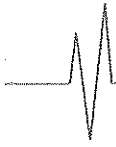

Pluriservicios Biomédicos S.A. de C.V.

EQUIPO MEDICO Y SOPORTE TECNICO
R.F.C. PBI0312022S1

19 27018027 SA1360

Rueda de 5"
con freno y
steer, PARA
CAMA MARCA
HILL ROM
MODELO
CENTRA.

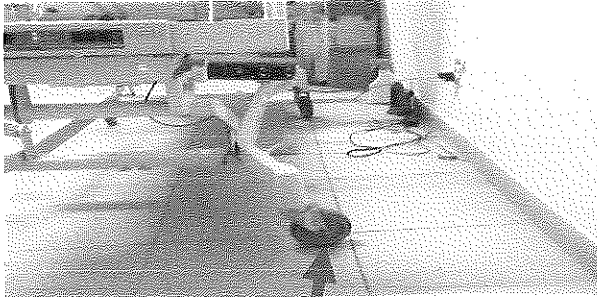

\$ 3,500.00 \$ 3,500.00

20 27017623 SA138
4

Cubierta porta
membrana
barandal
derecho, para
cama marca
Hill Rom

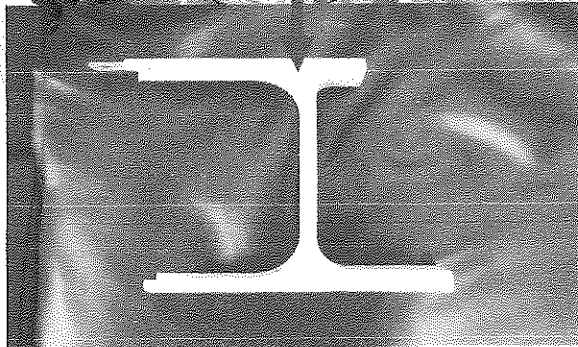
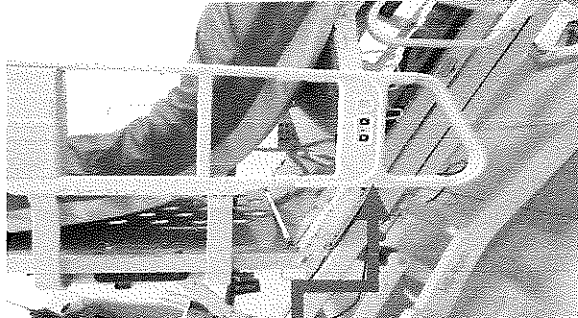

\$ 1,591.00 \$ 1,591.00

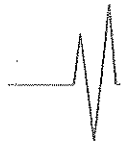

Pluriservicios Biomédicos S.A. de C.V.

EQUIPO MEDICO Y SOPORTE TECNICO
R.F.C. PBI0312022S1

21 27018028 SA148
3

Rueda de 8"
con freno
centralizado
para cama
marca Hill Rom
modelo Century
CC

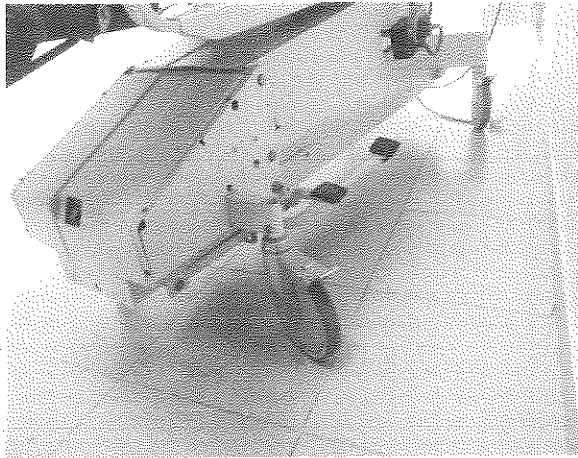

\$ 4,370.00 \$ 4,370.00

22 27017612 SA173
7

Unidad de
potencia recon
upgr120w/ft
para cama
marca Hill Rom
modelo P1900

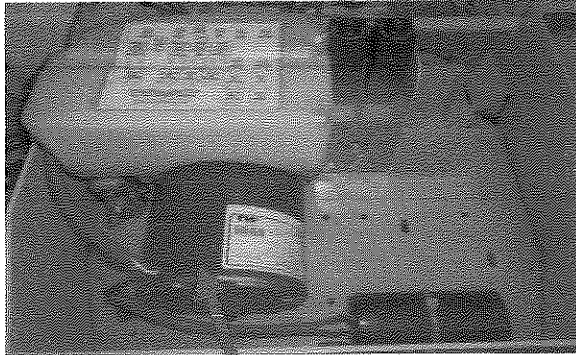

\$ 68,400.00 \$ 68,400.00

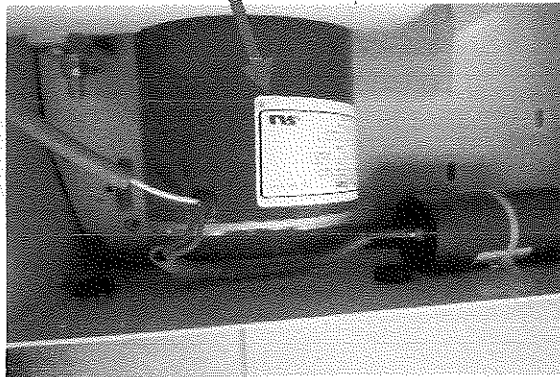



Pluriservicios Biomédicos S.A. de C.V.

EQUIPO MEDICO Y SOPORTE TECNICO
R.F.C. PBI0312022SI

23 27017613 126327 Rueda de 5" libre para cama Hill Rom modelo Centra \$ 2,500.00 \$ 2,500.00

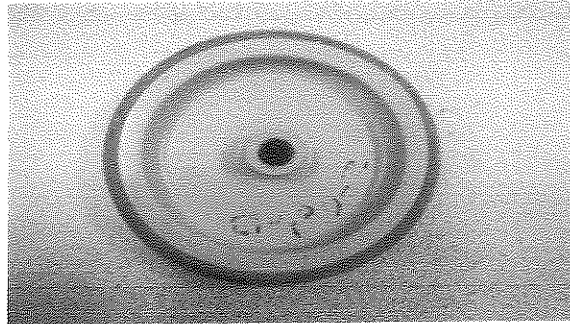

24 27017947 Colchón NP 150 \$ 13,775.00 \$ 13,775.00

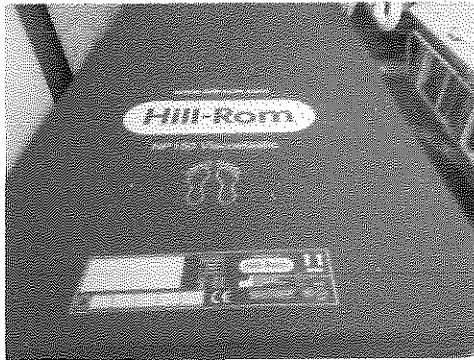

25 27017948 COLCHON NP50 \$ 7,125.00 \$ 7,125.00

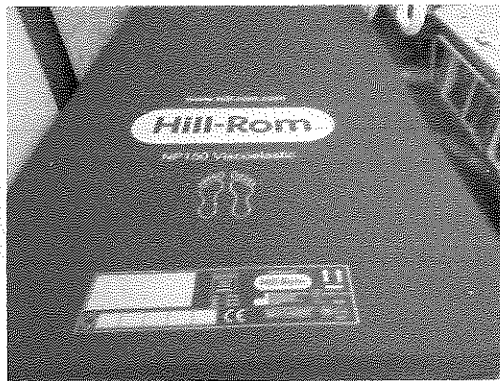

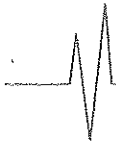

Pluriservicios Biomédicos S.A. de C.V.

EQUIPO MEDICO Y SOPORTE TECNICO
R.F.C. PBI0312022SI

26 27017953 146483

Pantalla para
CAMA MARCA
HILL ROM
MODELO
P1900 TOUCH

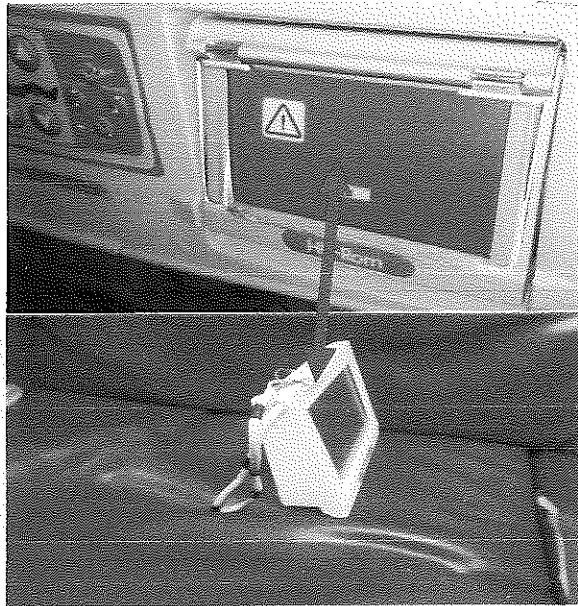

\$ 42,899.00 \$ 42,899.00

27

Derecho2
7017954

Derecha No.
de
parte
147340
102

Membrana lado
derecho para
cama marca
Hill Rom
modelo P
1900... (cama
con pantalla
Touch)

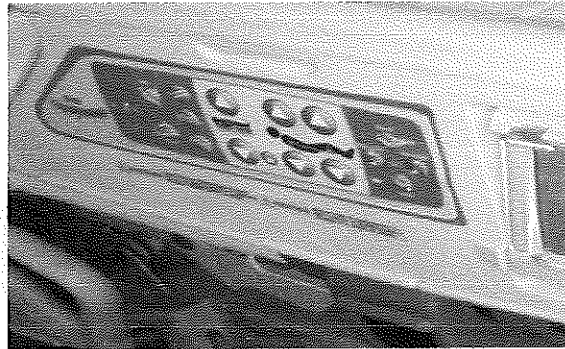

\$ 4,000.00 \$ 4,000.00

Izquierdo
27017955

Izquierda No.
de
parte
147340
101

Membrana lado
izquierdo para
cama marca
Hill Rom
modelo P
1900... (cama
con pantalla
Touch)

28 27017956

491021
01

Membrana
llamada de
enfermera para
cama marca
Hill Rom
modelo P1900

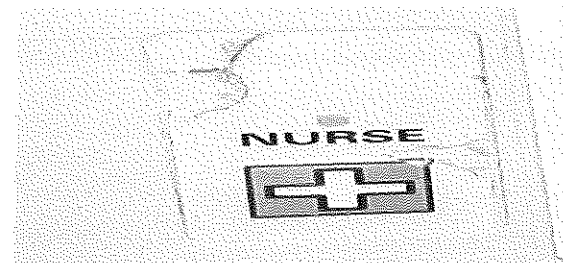

\$ 1,200.00 \$ 1,200.00

Francisco J Macín No. 103 Col. C.T.M Atzacolco Del. Gustavo A. Madero C.P. 07090

Tel . 55395817, 55399423 E-mail: atención@pluriservicios.com.mx

pluriserviciossadecv@prodigy.net.mx

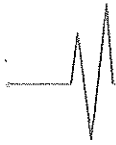

Pluriservicios Biomédicos S.A. de C.V.

EQUIPO MEDICO Y SOPORTE TECNICO
R.F.C. PBI0312022S1

29 270177959

Membrana para
cama MARCA
HILL ROM
MODELO
VERSA CARE
BARANDAL
DERECHO



\$ 4,000.00 \$ 4,000.00 ✓

30 27017960

Membrana para
cama MARCA
HILL ROM
MODELO
VERSA CARE
BARANDAL
IZQUIERDO



\$ 4,000.00 \$ 4,000.00 ✓

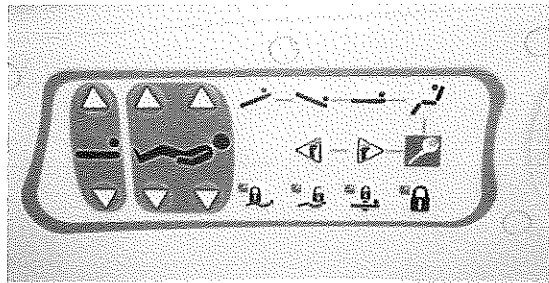

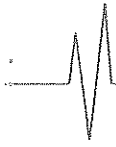
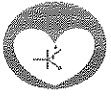

Pluriservicios Biomédicos S.A. de C.V.

EQUIPO MEDICO Y SOPORTE TECNICO
R.F.C. PBI0312022S1

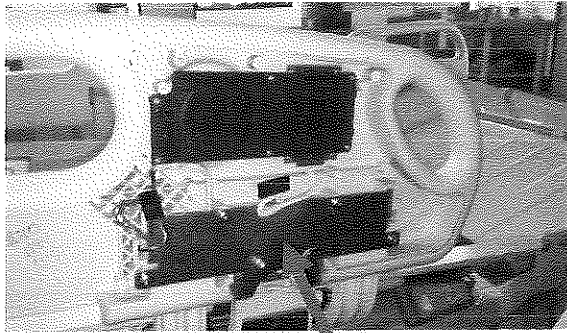

31 28009189

ASSY*
66614,
BRD*6
6613
REV4

Tarjeta de control

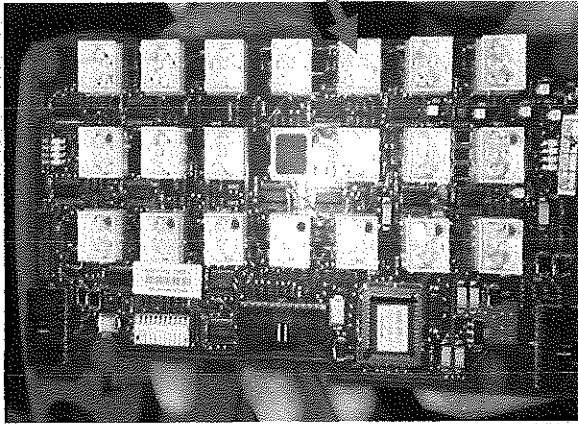

\$ 13,000.00 \$ 13,000.00

32 27017961

Etiqueta para
cama MARCA
HILL ROM
MODELO
VERSA CARE
LADO
DERECHO
DEL
BARANDAL DE
PIECERA.



\$ 2,000.00 \$ 2,000.00

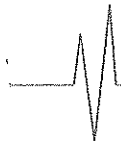

Pluriservicios Biomédicos S.A. de C.V.

EQUIPO MEDICO Y SOPORTE TECNICO
R.F.C. PBI0312022S1

33 27017963

Sensores emisor y receptor para cama marca hill Rom modelo Versa Care.....los sensores están colocados a los extremos de las llantas (sensores de bloqueo)

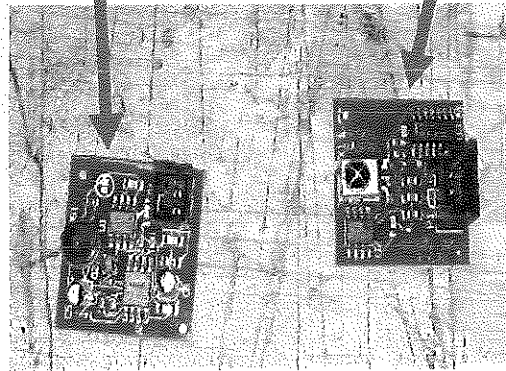
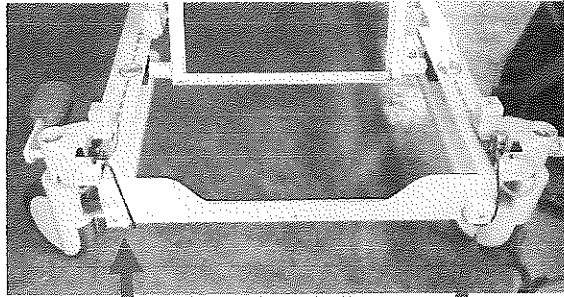

\$ 1,195.00 \$ 1,195.00

34

Derecho 27017967
izquierdo 27017968

SA1784

Cable de intercomunicación lado derecho para barandal de la cama marca Hill Rom modelo P1900.....al parecer tiene el número de parte SA1784

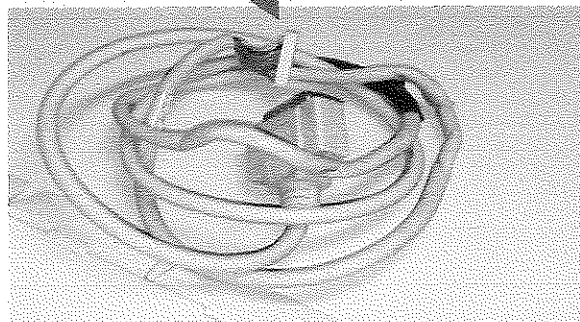
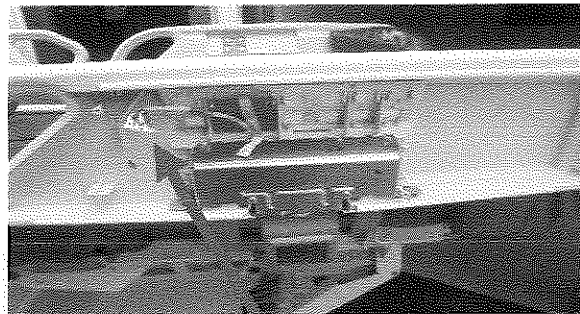

\$ 555.00 \$ 555.00

Cable de intercomunicación lado izquierdo para barandal de la cama marca Hill Rom modelo P1900

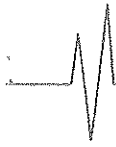

Pluriservicios Biomédicos S.A. de C.V.

EQUIPO MEDICO Y SOPORTE TECNICO
R.F.C. PBI0312022SI

35 27017669

Acoplador

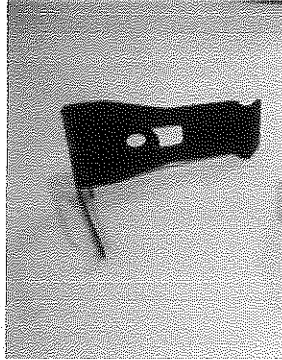

\$ 322.00

\$ 322.00

36 27017970

Tuerca de elevación

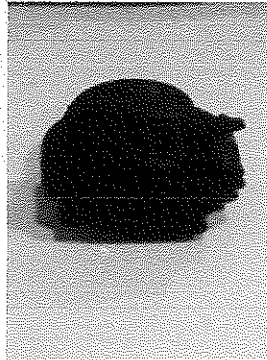

\$ 235.00

\$ 235.00

37 27017977

Interruptor de cambio

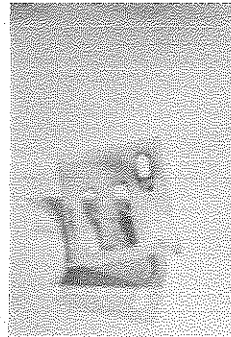

\$ 322.00

\$ 322.00

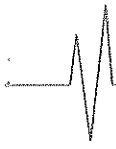

Pluriservicios Biomédicos S.A. de C.V.

EQUIPO MEDICO Y SOPORTE TECNICO
R.F.C. PBI0312022S1

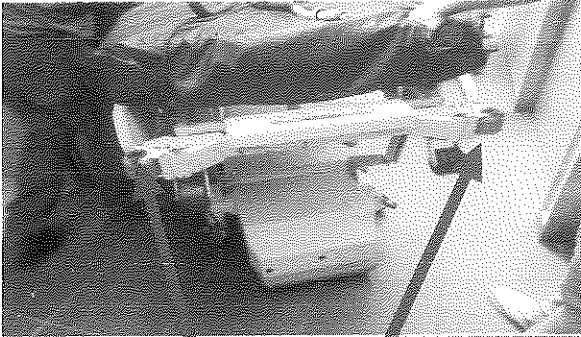
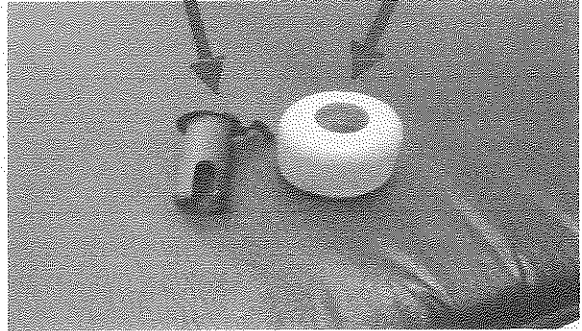
38	27018029	Bumper pin No. de parte 471530		Rolle bumpers de CAMA P1900 TOTAL CARE	\$ 2,191.00	\$ 2,191.00
		1				
		Bumper No. de parte 47219				

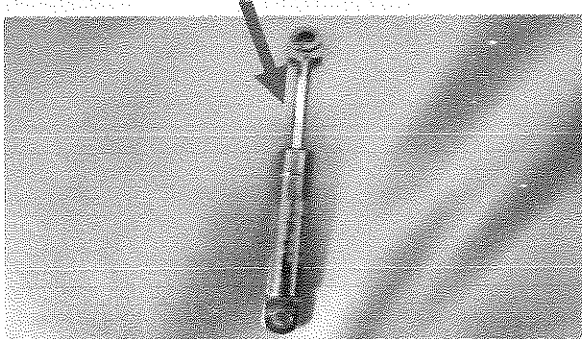
39	27018023	Amortiguadores de barandales de CAMA P1900 TOTAL CARE		Amortiguadores de barandales de CAMA P1900 TOTAL CARE	\$ 1,120.00	\$ 1,120.00
						

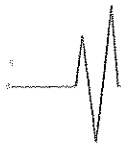

Pluriservicios Biomédicos S.A. de C.V.

EQUIPO MEDICO Y SOPORTE TECNICO
R.F.C. PBI0312022S1

40 27017971 36250

KIT DE
ACOPLAMIEN
TO
(COUPLING
ASSEMBMBLY
)

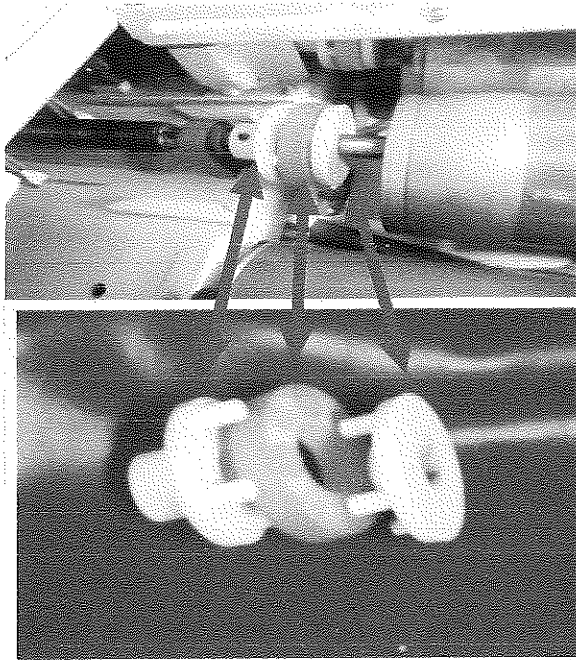

\$ 422.00 \$ 422.00

41 27018030

SA0106
9
VARILL
A de
trende
mburg

Varilla de
trende
mburg
para cama
marca Hill Rom
modelo 425

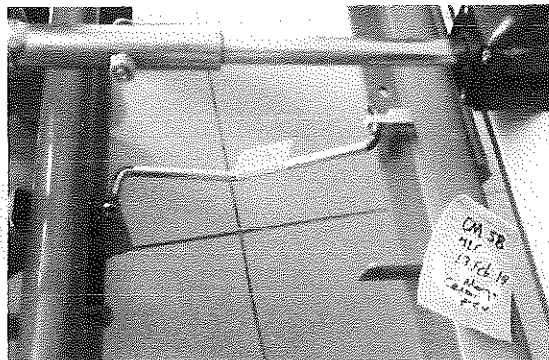

\$ 1,484.00 \$ 1,484.00

SA0107
0
VARILL
A DE
REVER
SA



Pluriservicios Biomédicos S.A. de C.V.

EQUIPO MEDICO Y SOPORTE TECNICO
R.F.C. PBI031202281

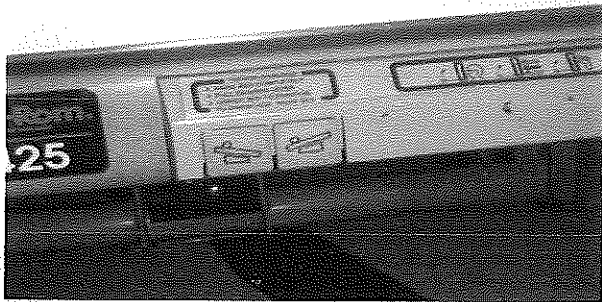
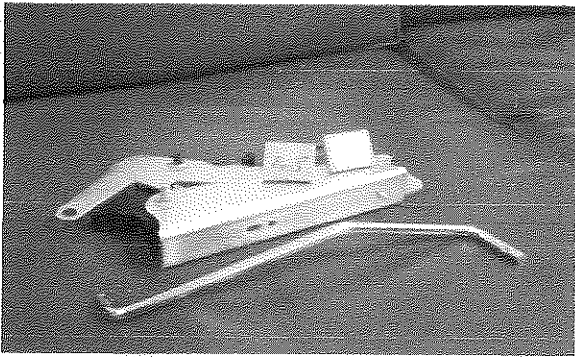
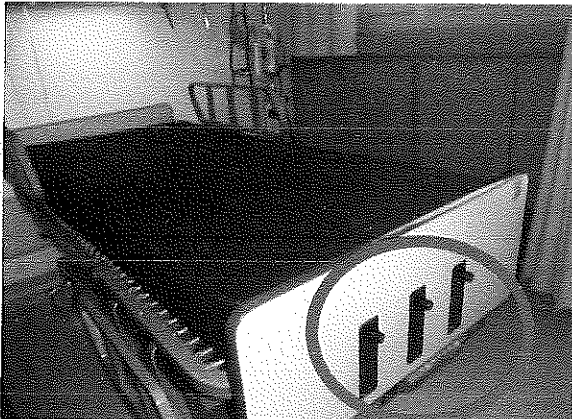
42	27018024	24710 TREN DLEM BURG 24709 REVE RSA TREN DLEM BURG	Botones de trendeamburg y reversa de trendeamburg cama manual 425		\$ 1,110.00	\$ 1,110.00
43	27018025	SA095 9	MECANISMO DE TRENDEMBU RG		\$ 1,558.00	\$ 1,558.00
44	27017974	24594 (2)SA0 1015	Charolas y manivelas para camas marca Hill Rom modelo 425 (CRANK INSERT		\$ 2,230.00	\$ 2,230.00

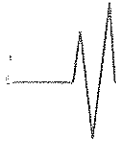

Pluriservicios Biomédicos S.A. de C.V.

EQUIPO MEDICO Y SOPORTE TECNICO
R.F.C. PBI0312022SI

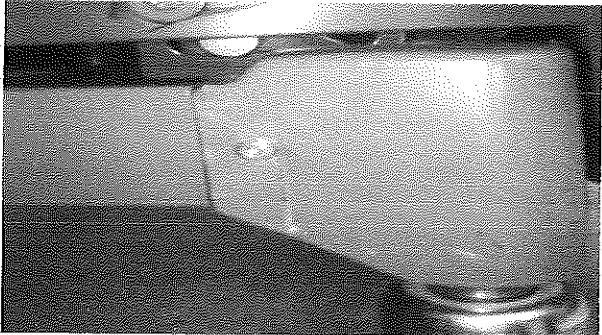
45	27017640	28727	CRANK ENSEMBLY (MANIVELA COMPLETA		\$ 1,101.00	\$ 1,101.00 ✓
46	27017978	44100	Cubierta de llantas para cama marca Hill Rom modelo 424		\$ 480.00	\$ 480.00 ✓

Esta cotización tiene una vigencia hasta el 31 de Diciembre del 2021

ESTOS PRECIOS NO INCLUYEN I.V.A.

Sin más por el momento y agradeciendo de antemano su atención, quedo a sus órdenes para cualquier duda o aclaración.

ATENTAMENTE

Oscar Martínez Sánchez
Representante Legal